

LiFePO4 Battery System

 **SUNESS**

 **SUNESS**

USER MANUAL



EV-5.12M

To ensure proper use, please read this manual thoroughly before operation

Contents

- 1. INTRODUCTION1
- 2. SYMBOLS1
- 3. SAFETY2
- 4. PRECAUTION AND INSTALLATION2
 - 4.1 Precaution2
 - 4.2 Installation2
- 5. EMERGENCY RESPONSE2
 - 5.1 Warning labels3
- 6. PRODUCT INFORMATION3
 - 6.1 Battery module specifications3
- 7. ELECTRICAL CONNECTIONS4
 - 7.1 Battery system features4
 - 7.2 Electrical interface description of EV-5.12M4
 - 7.3 Turn on / off5
 - 7.4 Description for communication port5
- 8. INSTALLATION7
 - 8.1 Items in the package7
 - 8.2 Tools7
 - 8.3 Installation instructions8
 - 8.4 Terminal connection9
 - 8.5 Connection for parallel mode10
 - 8.6 LCD display indicators11
 - 8.7 LED indication indicators12
 - 8.8 Communication instructions14
 - 8.9 Communication inverter type selection15
- 9. WARRANTY17
- 10. TROUBLESHOOTING AND MAINTENANCE17
 - 10.1 Maintenance17











1. INTRODUCTION

This manual includes instructions for battery installation, commissioning, maintenance and fault diagnosis.

Batteries utilize Lithium Iron Phosphate chemistry. This manual is designed for qualified personnel only. All operations provided in this manual should be executed by authorized and qualified technicians only.

Once the setup is complete, the installer ought to comprehensively brief the user on every precautionary guideline.

2. SYMBOLS

	Caution, risk of electric shock.
	Neither place nor install near flammable or explosive materials.
	Install the product out of reach of children.
	Read the instruction manual before starting installation and operation.
	Do not dispose of the product with household wastes.
	Recyclable.
	Disconnect the equipment before carrying out maintenance or repair.
	Observe precautions for handling electrostatic discharge sensitive devices.
	Earth wire indicator
	Caution, risk of electric shock, energy storage timed discharge.

3. SAFETY

Any operation on the batteries should be handled by authorized technicians, it is understood that the technicians should familiarize themselves with this manual before any maintenance or installation is carried out on the system.

4. PRECAUTION AND INSTALLATION

4.1 Precaution

- Do not expose battery to open flame.
- Do not place the product under direct sunlight.
- Do not place the product near flammable materials, it may lead to fire or explosion.
- Store in a cool and dry place with space.
- Store the product on a flat surface.
- Store the product out of reach of children and animals.
- Do not damage the unit by dropping, deforming, impacting, cutting or penetrating with a sharp object. It may cause leakage of electrolyte or fire.
- Do not touch any liquid spilled from the product. There is a risk of electric shock or damage to skin.
- Always handle the battery wearing the insulated gloves.
- Do not step on the product or place any foreign objects on it. This can result in damage.
- Do not charge or discharge damaged battery.

4.2 Installation

- After unpacking, please check the product if there is any damage or miss part.
- Make sure that the inverter and battery is completely turned off before commencing installation.
- Do not interchange the positive and negative terminals of the battery.
- Ensure that there is no short circuit of the terminals or with any external device.
- Do not exceed the battery voltage rating of the inverter.
- Do not connect the battery to any incompatible inverter.
- Do not connect batteries with different types.
- Please ensure that all the batteries are grounded.
- Do not open the battery to repair or disassemble. Only SUNESS technicians are allowed to carry out any such repairs.
- In case of fire, use only dry powder fire extinguisher. Liquid extinguishers should not be used.
- Install the battery away from children or pets.
- Do not use battery in high static environment where the protection device might be damaged.
- Do not install with other brand batteries or cells.

5. EMERGENCY RESPONSE

The batteries comprise of multiple batteries connected in series, It is designed to prevent hazards or failures. However, SUNESS cannot guarantee absolute safety. Under exposure to the internal materials of the battery the following recommendations should be carried out by the user.

- If there has been inhalation, please leave the contaminated area immediately and seek medical attention.
- If there has been contact with eyes, rinse the eyes with running water for 15 minutes and seek medical attention immediately.
- If there has been contact with the skin, wash the contacted area with soap thoroughly and seek medical attention immediately.
- If there has been ingestion, induce vomiting and seek medical attention.

Fire situation

Use a FM-200 or Carbon Dioxide (CO₂) fire extinguishers to extinguish the fire if there is a fire in the area where the battery pack is installed. Wear a gas mask and avoid inhaling toxic gases and harmful substances produced by the fire.

5.1 Warning labels

Warning labels and other relevant labels are attached on the battery pack.

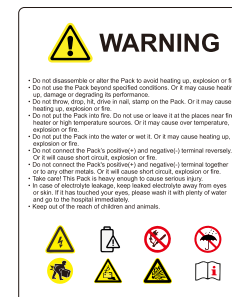
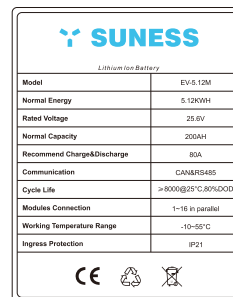

6. PRODUCT INFORMATION

EV-5.12M photovoltaic energy storage system is a 24V energy storage system based on Lithium Iron phosphate battery. It is equipped with a customized battery management system(BMS), Which is designed for energy storage applications of household photovoltaic power generation users. In the daytime, the excess power of photovoltaic generation can be stored in the battery. During the night or as required, the stored energy can be provided to the electrical equipment and appliances, it can improve the use efficiency of photovoltaic power generation, peak shaving, and provide emergency standby power.

6.1 Battery module specifications

Models	EV-5.12M
Total Energy	5.12KWH
Capacity	200Ah
Nominal Voltage	25.6V
Voltage Range	24V-28.8V
MAX. Charge & Discharge Current	80A
Peak Charge & Discharge Current(for10sec.)	100A
Scalable	1~16 in parallel
Communication	CAN,RS485
Enclosure Protection Rating	IP21
Charging Temp Range	0~55°C
Discharging Temp Range	-10~55°C
Cycle Life	≥ 8,000 Cycle@ 80% DOD / 25°C / 0.5C, 60%EOL
Warranty	10 years
Certification	IEC62619,UN38.3,CE
Net Weight(KG)	45KG
Product Dimension(MM)	660×430×185MM

Recommended Settings

Lithium battery pack is different from lead-acid battery, so for the devices which you connect with the battery pack for charging or discharging, such as inverters, MPPT charge controllers or UPS, please implement pre-settings as recommended settings as below before you launched them.

Setting Recommendations	EV-5.12M
Max. Charging Voltage	28.8V
Floating charging Voltage	28.8V
Max. Charging & Discharging Current	80A* N
Cut-off voltage	24V

Notes: "N" means the amount of battery packs connected in parallel.

7. ELECTRICAL CONNECTIONS

7.1 Battery system features

The batteries have been fitted with multiple protection systems to ensure the safe operation of the system. Some of the protection system includes:

- Inverter interface protection: Over voltage, Over current, External Short Circuit, Reverse Polarity, Ground Fault, Over Temp, surge current.
- Battery Protection: Internal Short Circuit, Over voltage, over current, over temp, Under voltage The battery system contains the following Interface to allow it connected and operated efficiently.

7.2 Electrical interface description of EV-5.12M

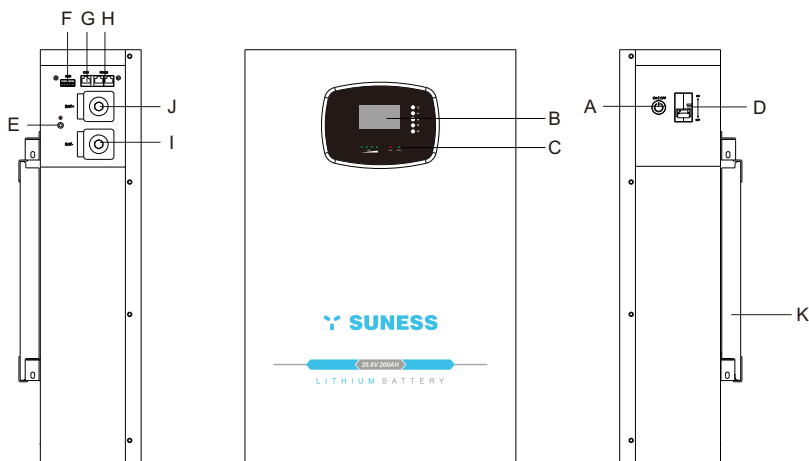

Code	Name
A	Power Switch
B	LCD Display
C	LED Display
D	Power Breaker
E	GND
F	ADD
G	CAN Communication
H	RS485 Communication
I	BAT-
J	BAT+
K	Wall mount

7.3 Turn on / off

Turn on: Turn the power circuit breaker to ON position and turn on the power button, the LCD can display the battery pack data, while the battery pack is waiting for charging and discharging mode.

Turn off: Turn the power circuit breaker to OFF position and turn off the power button, wait for a period of time for the LCD to turn off, while the battery pack enters the shutdown mode.

7.4 Description for communication port

External communication

CAN Communication: The battery pack can communicate with the inverter via CAN, baud rate: 500K.

RS485 Communication: The battery pack can communicate with the host computer via RS485 for data communication, baudrate:9600.

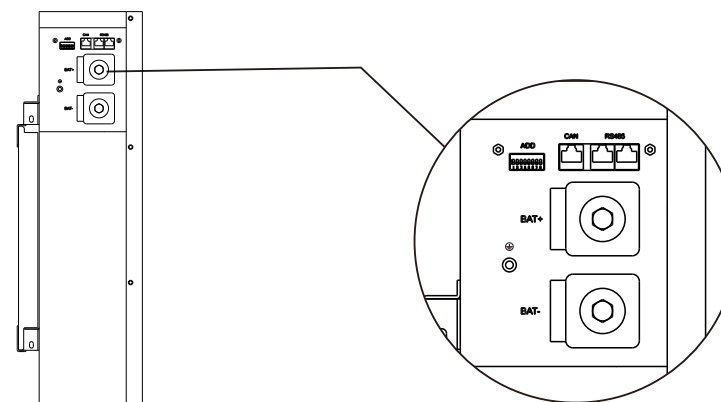

CAN

Pin	Function Definitions	Function Declaration
1	NC	
2	NC	
3	NC	
4	CANH	CANH
5	CANL	CANL
6	NC	
7	NC	
8	NC	

RS485

Pin	Function Definitions	Function Declaration
1	485-1B	RS485-1B
2	485-1A	RS485-1A
3	DI+	DI+
4	485-2A	RS485-2A
5	485-2B	RS485-2B
6	DI-	DI-
7	485-1A	RS485-1A
8	485-1B	RS485-1B

RS485

Pin	Function Definitions	Function Declaration
1	485-1B	RS485-1B
2	485-1A	RS485-1A
3	DO+	DO+
4	485-2A	RS485-2A
5	485-2B	RS485-2B
6	DO-	DO-
7	485-1A	RS485-1A
8	485-1B	RS485-1B

8. INSTALLATION

8.1 Items in the package

Please check if the following items are included with the package:



Code	Items	Code	Items
1	Wall bracket	4	User manual
2	Communication cable 1	5	Guarantee card
3	screws	6	Positive and Negative wires

8.2 Tools



Screw Driver



Crimping Modular



Electrical Safety Shoes



Multimeter



Insulated Gloves



Safety Goggles



Pliers



cable ties

8.3 Installation instructions

Requirements for Installation Location

- A solid support surface must be available (e.g., concrete or masonry).
- The installation location must be indoors.
- The installation location must be inaccessible to children.
- The installation location must be tolerable for the weight and dimensions of the battery system.
- The installation location must not be exposed to direct sunlight.
- The installation location must not be close to open flame or flammable substances.
- The altitude of the installation location should be less than 3000m.
- The ambient temperature should be between -10°C and +55°C.
- The relative humidity should be range from 5% to 95%.

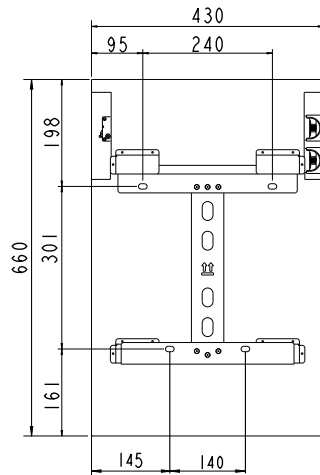

Installation procedure

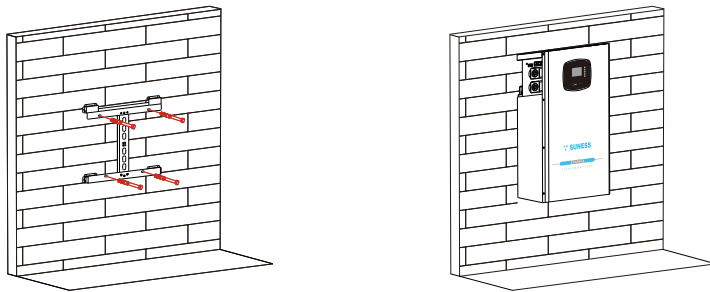

Installation environment



Max +55°C



Min -10°C



RH.+5%~+95%

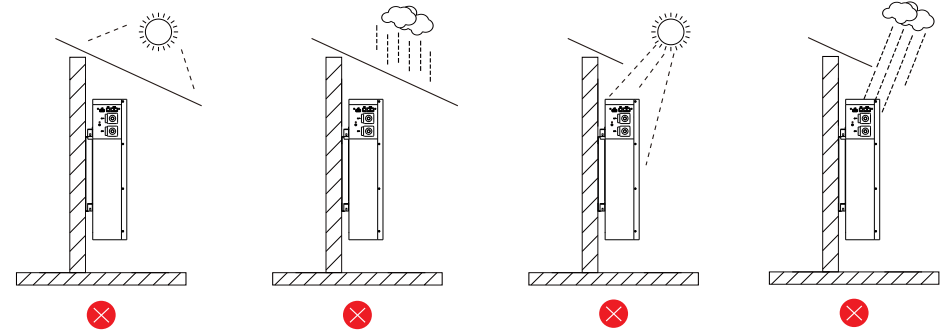

8.4 Terminal connection

Power terminal

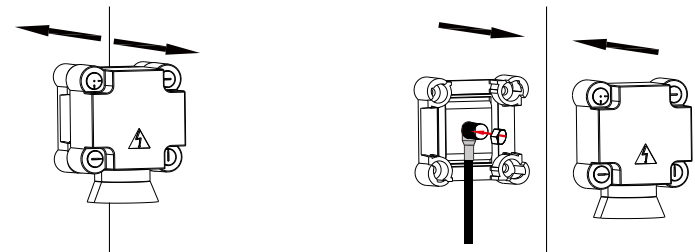

Note: Press the position indicated in the figure above before disconnecting the power terminal.

Communication terminal

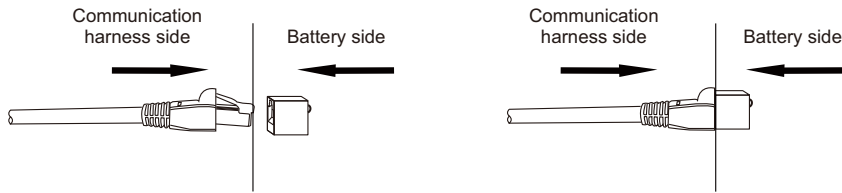

8.5 Connection for parallel mode

The EV-5.12M battery support to be connected in parallel for expansion. If you need one more battery bank work in parallel mode, connect the battery as shown in Figure 1.

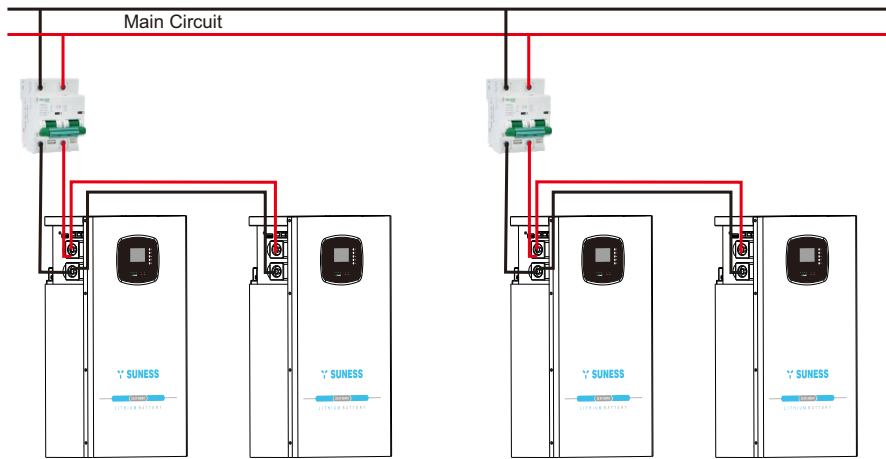

Step 1: The parallel connection of four battery packs is presented in Figure 1.

Note: After completing the outlined steps, proceed by connecting one of the battery packs' positive and negative terminals to the inverter. Once the correct connection of battery, inverter and controller being confirmed, you can start the whole system and enjoy using it without issues.

8.6 LCD display indicators

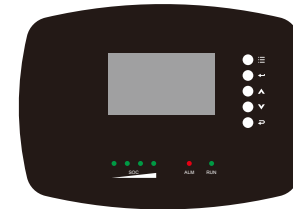

Buttons (from top to bottom)

- Menu: Menu button, press to go into setting.
- Enter: Enter submenu, press to confirm or go into submenu.
- UP: Cursor up/page up, press to choose the previous selection.
- Down: Cursor down/page down, press to choose the next selection.
- Esc: Cancellation, press to cancel or escape the setting.

LCD light-up method

BMS hibernation: Press menu to light up the LCD.
The LCD display will go into sleep mode within 1 minute without any operation: press any button to light up the LCD.

Version information

- BMS version information
 - BMS software versions: xxxxxxxx (BMS reads the last 8 bits of the software version)
 - BMS hardware version: xxxxxxxx (i.e. PCB version number)
- LCD version information
 - LCD software version: xxxxxxxx
 - LCD hardware version: xxxxxxxx
- Language setting
 - Chinese
 - English

Battery parameter acquisition

- Total voltage: xxxV
- Current: xxxxA (Charge as '+', discharge as '-')
- Temperature acquisition(Full screen page turn)
 - Cell temperature 01~04: xx°C
 - PCB temperature 02: xx°C(Communication failure is displayed as temperature 05:00 °C)
 - Environment temperature: xx °C(Communication failure is displayed as temperature 06:00 °C)
- Cell voltage (Full screen page turn)
 - Voltage 01~16: xxxmV
- SOC: xxx%
- Number of cycles: xxxx

Battery working state (Full screen page turn)

- Status: Idle / Charging / Discharging
- Alarm Status (Full screen page turn)
 - Overvoltage alarm / Undervoltage alarm / Overtemperature alarm / Undertemperature alarm / Capacity alarms / Differential pressure alarm / Overcurrent alarm / Anti-connection alarm: Yes / No
- Protection Status (Full screen page turn)
 - Overvoltage protection / Undervoltage protection / Over-temperature protection / Undertemperature protection / Overcurrent protection / Short-circuit protection: Yes / No
- Failure alarm (Full screen page turn)
 - Sample line / Charging tube / Discharge tube / Sampling chip: Ok / Fail
- Number of short circuit protection: xxxx
- Temperature protection times: xxxx
- Overcurrent protection times: xxxx
- Overcharge protection times: xxxx
- Overdischarge protection times: xxxx

8.7 LED indication indicators

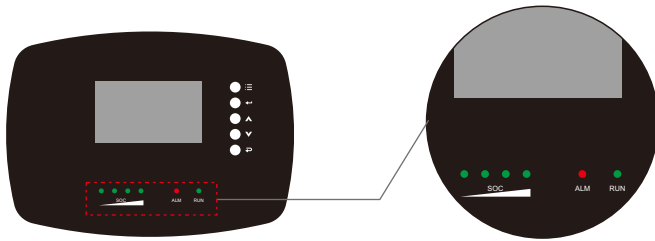

The BMS features 6 external LED indicator lights. 1. 4 white-green capacity indicator lights. 2. 1 red alarm indicator light. 3. 1 white-green operational indicator

LED flashing status description

Flashing status	ON	OFF
Flash 1	0.25S	3.75S
Flash 2	0.5S	0.5S
Flash 3	0.5S	1.5S

SOC light display and capacity correspondence

Status	Charge				Discharge			
	L1 ●	L2 ●	L3 ●	L4 ●	L1 ●	L2 ●	L3 ●	L4 ●
0~25%	Flash	OFF	OFF	OFF	ON	OFF	OFF	OFF
25~50%	ON	Flash	OFF	OFF	ON	ON	OFF	OFF
50~75%	ON	ON	Flash	OFF	ON	ON	ON	OFF
75~100%	ON	ON	ON	Flash	ON	ON	ON	ON
RUN lights ●	ON				Flash 3			

Operational status description

System Status	Protection/Alarm/Normal	RUN	ALM	SOC LED				Description
		●	●	●	●	●	●	
Power off	Hibernation	OFF	OFF	OFF				OFF
Standby	Normal	Flash 1	OFF	OFF				Standby
	Alarm	Flash 3	Flash 3	OFF				ALM and RUN lights Flash 3
Charge	Normal	ON	OFF	Based on capacity indication				Maximum SOC LED Flash 2
	Overvoltage alarm	ON	OFF	Based on capacity indication				Maximum SOC LED Flash 2
	Overcurrent alarm	ON	Flash 3	Based on capacity indication				Maximum SOC LED Flash 2
	Overvoltage protection	ON	OFF	ON				
	Current-limited charging	ON	OFF	Based on capacity indication				Maximum SOC LED Flash 2
Discharge	Normal	Flash 3	OFF	Based on capacity indication				Based on capacity indication
	Alarm	Flash 3	Flash 3	Based on capacity indication				ALM and RUN lights Flash 3
	Overcurrent, short-circuit and reverse connection protection	OFF	ON	OFF				
Temperature	Charge alarm	ON	Flash 3	Based on capacity indication				Maximum SOC LED Flash 2
	Discharge alarm	Flash 3	Flash 3	Based on capacity indication				ALM and RUN lights Flash 3
	Protection	OFF	ON	OFF				

Note:

Alarms will activate for the following conditions: Low capacity, Excessive voltage differentia, Low cell voltage, Low pack voltage, Charging overcurrent, Discharge overcurrent, High cell temperature, Low cell temperature, High ambient temperature, Low ambient temperature, High MOS temperature.

8.8 Communication instructions

CAN Communication

The battery pack can communicate with the inverter via CAN protocol, baud rate:500K

RS485 Communication

The battery pack can communicate with the host computer via RS485 protocol for data communication, baud rate: 9600

DIP switch

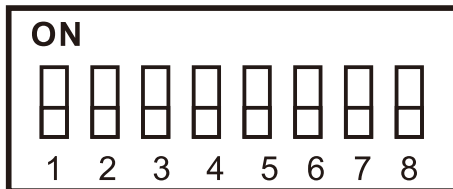

DIP switches bit 1 to bit 8 are defined: bit 1 to bit 4 for setting the address, bit 5 to bit 8 for setting the orders of slaves.

Slave settings: bit 1 to bit 4 are set according to the device order, slave address range from 1 to 15. Bit 5 to bit 8 should be set as 0. Please refer to the forming table.

Host settings: bit 1 to bit 4 should be set as 0, the host address is fixed to 0, bit 5 to bit 8 are set according to the amount of slaves connected in parallel. Please refer to the forming table.

Host settings

Number of in parallel	DIP switches position				Instruction
	#5	#6	#7	#8	
2	ON	OFF	OFF	OFF	2 units in parallel
3	OFF	ON	OFF	OFF	3 units in parallel
4	ON	ON	OFF	OFF	4 units in parallel
5	OFF	OFF	ON	OFF	5 units in parallel
6	ON	OFF	ON	OFF	6 units in parallel
7	OFF	ON	ON	OFF	7 units in parallel
8	ON	ON	ON	OFF	8 units in parallel
9	OFF	OFF	OFF	ON	9 units in parallel
10	ON	OFF	OFF	ON	10 units in parallel
11	OFF	ON	OFF	ON	11 units in parallel
12	ON	ON	OFF	ON	12 units in parallel
13	OFF	OFF	ON	ON	13 units in parallel
14	ON	OFF	ON	ON	14 units in parallel
15	OFF	ON	ON	ON	15 units in parallel

Slave settings

Address	DIP switches position				Instruction
	#1	#2	#3	#4	
1	ON	OFF	OFF	OFF	Address 1
2	OFF	ON	OFF	OFF	Address 2
3	ON	ON	OFF	OFF	Address 3
4	OFF	OFF	ON	OFF	Address 4
5	ON	OFF	ON	OFF	Address 5
6	OFF	ON	ON	OFF	Address 6
7	ON	ON	ON	OFF	Address 7
8	OFF	OFF	OFF	ON	Address 8
9	ON	OFF	OFF	ON	Address 9
10	OFF	ON	OFF	ON	Address 10
11	ON	ON	OFF	ON	Address 11
12	OFF	OFF	ON	ON	Address 12
13	ON	OFF	ON	ON	Address 13
14	OFF	ON	ON	ON	Address 14
15	ON	ON	ON	ON	Address 15

8.9 Communication inverter type selection



Browser Scan(Android)



SUNESS

Note: Apple devices please search "SUNESS" in App store directly.

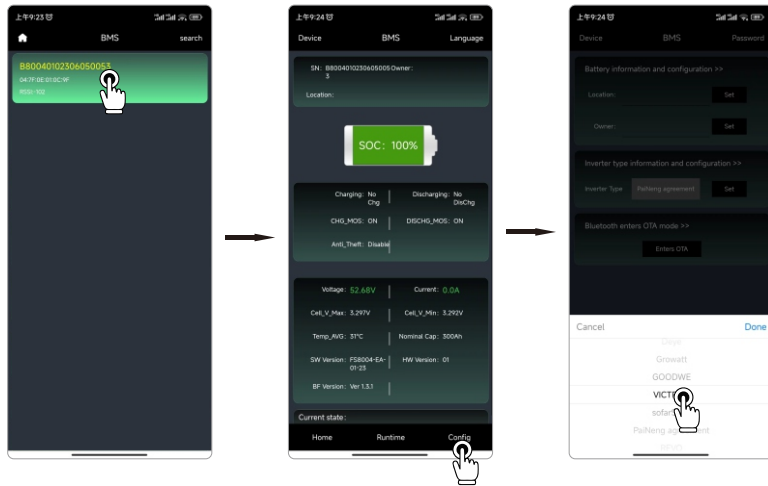

Step 2: Open the SUNESS app, search the device serial number and tap to choose it.

Step 3: Tap the Configure and select the inverter type

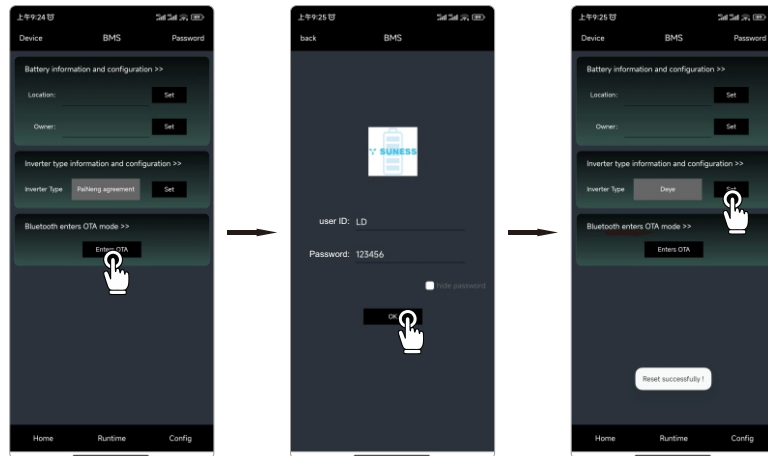

Step 4: Tap "Enter OTA", type the user name, user password, hit OK, and wait until "Reset successfully !" appear.

Note: User Name: LD; User Password: 123456

9. WARRANTY

The warranty does not cover defects caused by normal wear and tear, improper maintenance, transportation, storage, incorrect repair, modifications to the battery pack by third parties other than SUNESS, failure to comply with provided product specifications, or improper use or installation, including but not limited to the following:

- Damage during transportation or storage.
- Incorrect battery installation or maintenance.
- Use of the battery pack in inappropriate environments.
- Improper charging, discharging, insufficient charging, or deviation from the production circuitry specified in this manual.
- Incorrect or misuse of the product.
- Inadequate ventilation.
- Neglect of applicable safety warnings and instructions.
- Unauthorized personnel attempting to modify or repair.
- Acts of nature or force majeure (such as lightning, heavy rain, floods, fires, earthquakes, etc.).
- Apart from the warranties specified in this agreement, there are no other express or implied warranties. SUNESS is not liable for any subsequent or indirect damages caused by product specifications, batteries, or battery packs.

10. TROUBLESHOOTING AND MAINTENANCE

10.1 Maintenance

- 1.Regularly check whether the service environment of the battery meets the requirements, and the installation position should be far away from the heat source.
- 2.Regularly check whether the battery and its supporting terminals, connecting cables and indicator lights are normal.
- 3.The battery should be stored in an environment with a temperature range of -10°C to +55°C and should be periodically charged according to the table below. Charging temperature should not exceed 0.5°C (C-rate measures the discharge rate relative to the battery's maximum capacity). After long-term storage, the State of Charge (SOC) should decrease to 30%.

Storage environment temperature	Relative humidity of the storage environment	Storage time	SOC
Below -10°C	/	Not allowed	/
-10~25°C	5%~70%	≤ 12 months	25%≤SOC≤60%
25~35°C	5%~70%	≤ 6 months	25%≤SOC≤60%
35~55°C	5%~70%	≤ 3 months	25%≤SOC≤60%
Above 55°C	/	Not allowed	/

- To determine the issue based on the following points:

- Check if the red light on the LED display is illuminated.
- Verify if the battery can output voltage.

- Preliminary troubleshooting steps:

If the battery system is not functioning and the LCD does not light up when the DC switch is turned on and power is connected, please contact your local dealer.